



**COOL BREEZE**  
*Air Conditioning*

**Spare Parts Price  
List  
2015 - 2016**

Effective 1 October 2015

**AIRGROUP**  
Australia

## CONTENTS

Filter Pads	
Corner Posts and Accessories	
Polymer Casing - Sumps & Lids	
Winter Panels	
Louvres and Ember Guards	
Water Distribution Parts	
Water Manifold	
Water Feed Pipes	
Solenoids and Accessories	
Pumps	
Float Valve and Float Assembly	
Drain Valve and Fittings	
Fans and Motors	
Motors	
Motor Mounting Rings	
Fans	
Motor packs and Accessories	
Motor Packs (complete)	
Collets	
Accessories	
Capacitors	
Circuit Boards and Controllers	
Electronic Boards	
Controllers	
Multi-Core Control Cables	
Electrical Box & Accessories	
Zone Control	
Cables and Accessories	
Damper Motors	
Solectair , Solectair Uno & Solectair Plus	
Circuit Boards & Controllers	
Electrical Components and Accessories	
Cowling and Filter	
Motors and Accessories	
Fan and Accessories	
Miscellaneous Accessories	
Exploded View Down Discharge Heritage	
Exploded View Down Discharge Cascade	
Exploded View Down Discharge Twin Fan	
Exploded View Side Discharge S105	
Exploded View Side Discharge S240	
Exploded View Mobile M240	
Unit Colours, Controller Identification	

## FILTER PADS - COOLBREEZE

NOW AVAILABLE IN SETS OF 4 PADS

Part No.	Manufactured	Model	Description
SP4146/4	<b>CZ/CO/MB/MX</b>  <b>1994 - 1997</b> 30mm Water Distribution Strip at top of pads	80*	Set of 4 Pads
SP4148/4		105*	Set of 4 Pads
SP4150/4		130*	Set of 4 Pads
SP4152/4		160*	Set of 4 Pads
SP4154/4		185*	Set of 4 Pads
SP4156/4		210*	Set of 4 Pads
SP4157/4		250	Set of 4 Pads
SP4174/4		80	Set of 4 Pads
SP4176/4	<b>CZ/CO/MX</b> <b>1997 - 2000</b> Channel fitted with plastic insert and capping	105	Set of 4 Pads
SP4178/4		130	Set of 4 Pads
SP4180/4		160	Set of 4 Pads
SP4182/4		185	Set of 4 Pads
SP4184/4		210	Set of 4 Pads
SP4186/4		250	Set of 4 Pads
SP4300/4	<b>Heritage</b> <b>2000 - 2016</b> Channel fitted with plastic insert and capping	D095	Set of 4 Pads
SP4302/4		D125	Set of 4 Pads
SP4304/4		D160	Set of 4 Pads
SP4306/4		D195	Set of 4 Pads
SP4308/4		D230	Set of 4 Pads
SP4310/4		D255	Set of 4 Pads
SP4312/4	<b>Cascade</b> <b>2000 - 2016</b> Channel fitted with plastic insert and capping	C125	Set of 4 Pads
SP4318/4		C160	Set of 4 Pads
SP4324/4		C205	Set of 4 Pads
SP4330/4		C240	Set of 4 Pads

Only genuine CoolBreeze filter pads have the plastic cap and insert fitted

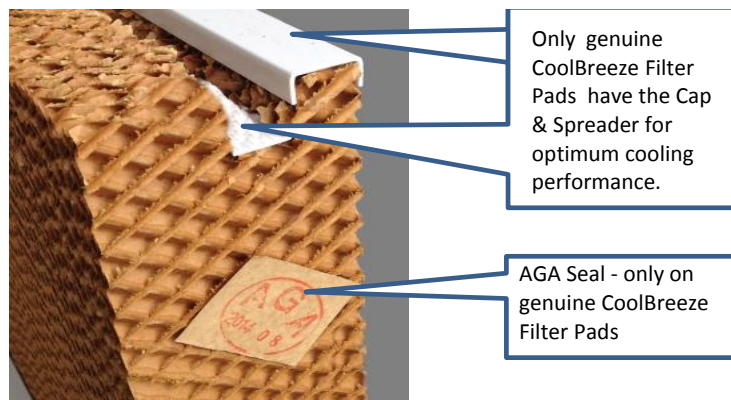

**FILTER PADS - COOLBREEZE**

INDIVIDUAL PADS

Part No.	Manufactured	Model	Description		
SP4100	Pre 1991	LP7*	Fibreglass Casing		
SP4101			Uvex Casing		
SP4102		LP9*	Fibreglass Casing		
SP4103			Uvex Casing		
SP4104		LP12*	Fibreglass Casing		
SP4105			Uvex Casing - Up distribution shrouds to be fitted		
SP4106		LP15*	Fibreglass Casing		
SP4107			Uvex Casing		
SP4106		LP16*	Fibreglass Casing		
SP4108			Uvex Casing		
SP4110		1991 - 1992	LP110*		
SP4112			LP125*		
SP4114	LP135*				
SP4116	LP160*				
SP4118	LP185*				
SP4120	1992	LP60* +	Pitched roof unit		
SP4122		LP85* +	Pitched roof unit		
SP4124		LP95* +	Pitched roof unit		
SP4125		LP110*			
SP4126		LP120*			
SP4128		LP150*			
SP4130		LP190*			
SP4132	1993	PR65* +	Pitched roof unit		
SP4134		PR90* +	Pitched roof unit		
SP4138		FP120*			
SP4140		FP140*			
SP4142		FP170*			
SP4144		FP200*			

\*30mm Water Distribution Strip at Top of Pads

+ Units fitted with 2 pads only

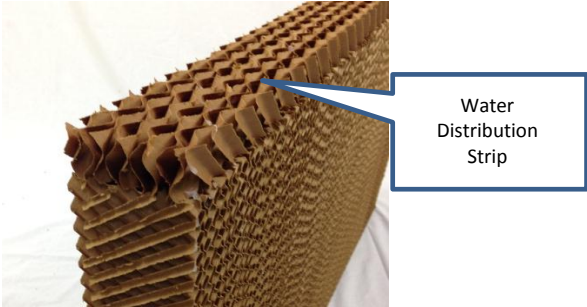

## FILTER PADS - COOLBREEZE

### INDIVIDUAL PADS

Part No.	Manufactured	Model	Description		
SP4570	<b>U/EX Series 2002 - 2006</b>	U/EX 125	Front pad		
SP4573			Back pad		
SP4571			Left side pads		
SP4572			Right side pads		
SP4574		U/EX 165	Front pad		
SP4577			Back pad		
SP4575			Left side pad		
SP4576			Right side pad		
SP4578			<b>U/EX Series 2002 - 2006</b>	U/EX 220	Front pad
SP4581					Back pad
SP4579	Left side pad				
SP4580	Right side pad				
SP4582	U/EX 260	Front pad			
SP4585		Back pad			
SP4583		Left side pad			
SP4584		Right side pad			
SP4611	<b>Ezycool</b>	L110	Std Dropper mdels		
SP4612			Roof Pitch model		

### Filter Pads - Commercial Units

SP4186	<b>Side Discharge 1995 - 2002</b>	S100*	Front pad
SP4188		S100*	Side pad
SP4186	<b>2002 - 2016</b>	S200* / P250*	All sides
SP4187		S240	All sides
SP4191		S105	Side pad
SP4190		S105	Front pad
SP4540		<b>Twin Fan</b>	D400
SP4542	D400		Front/back pads - 4 per unit
SP4544	D500		Side pads- 2 per unit
SP4546	D500		Front/back pads - 4 per unit
SP4189	<b>Mobile Units 2001 - 2002</b>	M240	Portable - 3 per unit
SP4187			<b>2002 - 2016</b>

### Miscellaneous

SP4340			Potassium Permanganate - Reduces odour when using new pads
--------	--	--	--

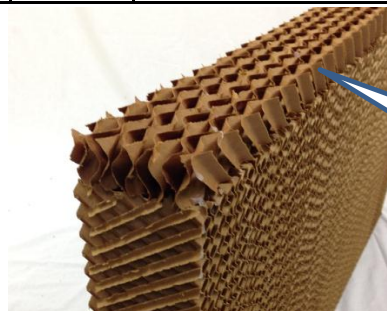

Water  
Distribution  
Strip

## CORNER POSTS AND ACCESSORIES

Specify Colours: \*Grey=Y, Green=N, Ebony=E, Red=R, Beige=B, Blue=U

Part No.	Manufactured	Model	Description
SP4036*	pre-2000	80	330mm High (inner and outer)
SP4038*		105	420mm High (inner and outer)
SP4040*		130/160	515mm High (inner and outer)
SP4044*		185	650mm High (inner and outer)
SP4046*		210	750mm High (inner and outer)
SP4062		250	950mm High (inner and outer)
SP4066*		Heritage 2000 - 2016	D095
SP4068*	D125		460mm (inner and outer) - 75mm
SP4070*	D160		460mm (inner and outer) - 100mm
SP4072*	D195		535mm (inner and outer) - 100mm
SP4074*	D230		650mm (inner and outer) - 100mm
SP4076*	D255		770mm (inner and outer) - 100mm
SP4078*	Cascade 2000 - 2016	C125	640mm H - Front posts
SP4080*		C125	275mm H Back posts
SP4082*		C160	640mm H - Front posts
SP4084*		C160	275mm H - Back posts
SP4086*		C205	760mm H - Front posts
SP4088*		C205	395mm H - Back posts
SP4090*		C240	870mm H - Front posts
SP4092*		C240	505mm H - Back posts
SP4061	Side Discharge 2002-2016	S105	930mm - 75mm Channel front - Beige
SP4059			930mm - 75mm Channel back left - Beige
SP4057			930mm - 75mm Channel back right - Beige
SP4061	1995 - 2001	S200	930mm - 75mm Channel - Beige
SP4093	2002 - 2016	S240	950mm - 75mm Back channel left - Beige
SP4094			950mm - 75mm Back channel right - Beige
SP4095			950mm - 100mm Channel Front - Beige
SP4530	Twin Fan	D400	Corner post 795mm high (4 per unit) - Beige
SP4534		D500	Corner post 960mm high (4 per unit) - Beige
SP4532		D400	Centre post 790mm high (2 per unit) - Beige
SP4536		D500	Centre post 955mm high (2 per unit) - Beige
SP4566		D500/400	Centre Post Support Bar
SP4564			Corner Post Bolt Pack - Beige (includes 6 x 6mm Polymer bolts stainless bolts, 6 x 8mm)
SP4062GY	Mobile Unit 2000 - 2002	M240	950mm - 75mmx 75mm Channel - Grey
SP4065U	Mobile Unit	M240	950mm - 75mmx100mm Channel - Left - Blue
SP4067U			950mm - 75mmx100mm Channel - Right - Blue
SP4063U			950mm - 100mmx100mm Channel Front- Blue (2 per unit)
SP4048	Pre 2000		Bolt Pack - To suit units manufactured up to 2000 (includes 8 x 6mm Stainless steel bolts complete with Dektite Washer)
SP4049*	All Units 2000 - 2016		Corner Post Bolt Pack - to suit Heritage, Cascade and Mobile, (includes 4 x 6mm Stainless bolts, 4 x 8mm Polymer bolts)

## POLYMER CASING (SUMPS AND LIDS)

Specify Colours: \*Grey=Y, Green=N, Ebony=E, Red=R, Beige=B, Blue=U

Part No.	Manufactured	Model	Description
<b>Sumps, Lids and Side Panels</b>			
SP1009*	<b>2000 - 2016 Heritage &amp; Cascade</b>		Moulded <b>Sump</b> - Heritage With shrouded cowling
SP1007*			Moulded <b>Sump</b> - Cascade With shrouded cowling
SP1010*	<b>2000 - 2016</b>		Moulded Lid - All models except S105 & Top Discharge
SP1530	<b>Twin Fan</b>	D400/ 500	Moulded <b>Sump</b> - Beige
SP1532			Moulded <b>Lid</b> - Beige
SP1080	<b>Mobile</b>	M240	Moulded <b>Sump</b> - Blue
SP1061			Moulded <b>Side Panel</b> - Blue includes motor cowling
SP1072	<b>Top Discharge 2000 - 2016</b>	All sizes	Moulded <b>Lid</b> -Beige includes corner reinforcing brackets
SP1053			Moulded <b>Sump</b> - Beige - specify Top Discharge
SP1059	<b>Side Discharge 2002 - 2016</b>	S105	Moulded Side Panel - Beige Suited to Counter-weight drain
SP1055		S105	Moulded Sump & Lid - Beige suits Counter-weight drain. Lid and sump not available separately
SP1053		S240	Moulded <b>Sump</b> - Beige - specify Side Discharge
SP1060		S240	Moulded Side Panel - Beige Suits Counter-weight drain.
<b>Winter Panels (4 per set)</b>			
SP1615*	<b>1994 - 2000</b>	80	735 x 310
SP1616*		105	735 x 400
SP1617*		130	735 x 495
SP1618*		160	840 x 495
SP1619*		185	840 x 630
SP1620*		210	840 x 730
SP1621*		250	840 x 930
SP1622*	<b>Heritage &amp; Cascade 2000 - 2016</b>	D095	830 x 370
SP1623*		D125/160	830 x 460
SP1624*		D 195	830 x 535
SP1625*		D230	830 x 650
SP1626*		D255	830 x 770
SP1627*		C 125/160	1 x Back, 1 x Front, 2 x Side
SP1628*		C205	1 x Back, 1 x Front, 2 x Side
SP1629*		C240	1 x Back, 1 x Front, 2 x Side

Note re winter panels: Pre 2000 colours are no longer available, current colours will be provided in the sizes above

## LOUVRES AND EMBER GUARDS

Specify Colours: \*Grey=Y, Green=N, Ebony=E, Red=R, Beige=B, Blue=U

Part No.	Manufactured	Model	Description
<b>Louvre Panels - Prices shown are for 1 louvre</b>			
SP063B	<b>1995 - 2016 Commercial</b>	S105	Front Louvre - Beige
SP065B			Side Louvre - Beige
SP063B		S200/240	All Louvres - Beige
SP063U		M240	All Louvres - Blue 2002-2016
SP066*	<b>Heritage 2000-2016</b>	D095	Louvre - Each
SP068*		D125/160	Louvre - each
SP070*		D195	Louvre - Each
SP072*		D230	Louvre - Each
SP074*		D255	Louvre - Each
SP076*	<b>Cascade 2000-2016</b>	C125/160	Front Louvre
SP078*		C125/160	Right Louvre
SP080*		C125/160	Left Louvre
SP082*		C125/160	Back Louvre
SP084*		C205	Front Louvre
SP086*		C205	Right Louvre
SP088*		C205	Left Louvre
SP090*		C205	Back Louvre
SP092*		C240	Front Louvre
SP094*		C240	Right Louvre
SP096*		C240	Left Louvre
SP098*		C240	Back Louvre
<b>Louvre Panels</b>			
SP0530	<b>Twin Fan</b>	FD400	Front/Back Small Beige, 4 required per unit
SP0532			Side Large Beige 2 required per unit
SP0534		FD500	Front/Back Small Beige 4 required per unit
SP0535			Side Large Beige 2 required per unit
<b>Louvre Panel - Ember Guard</b> - Specify colour* - Set of 4 (made to order)			
SP0516*	<b>Heritage &amp; Cascade 2000-2016</b>	D095	Ember Guards Set
SP0517*		D125/160	Ember Guards Set
SP0518*		D195	Ember Guards Set
SP0519*		D230	Ember Guards Set
SP0520*		D255	Ember Guards Set
SP0521*		C125/160	Ember Guards Set
SP0522*		C205	Ember Guards Set
SP0523*		C240	Ember Guards Set







## WATER DISTRIBUTION PARTS - Manifolds etc

Part No.	Manufactured	Model	Description	
<b>Water Manifold</b>				
SP2001	<b>1997 - 2000</b>	80-130	Water Manifold - Holes face down - Suit pads with plastic insert channel	
SP2007	<b>2000 - 2016</b>		Water Manifold Suits Heritage, Cascade and Top Discharge	
SP2009	<b>Side &amp; Top</b>	S105	Water Manifold - Side Discharge	
SP2011	<b>Discharge Units</b>	S240/ M240	Water Manifold - Side Discharge on 3 sides	
SP2043		All units	19mm Pump T Piece	
SP2528		All units excluding S105	Manifold Corner Piece repair kit	
SP2530	<b>Twin Fan</b>	D400/500	Water Manifold - One size fits all	
SP2602	<b>Ezycool</b>		Vertical L Series	
SP2604			Sloping L Series Roof Pitch models	
<b>Water Feed Pipes</b>				
SP2096	<b>2000 - 2016</b>	S200/240	950mm - No restrictor	
SP2097		S105	950mm - 9mm restrictor	
SP2100	<b>Heritage &amp; Cascade 2000-2016</b>	D095	370mm - 11mm restrictor	
SP2102		D125/160	460mm - 12mm restrictor	
SP2104		D195	535mm - No restrictor	
SP2106		D230	650mm - No restrictor	
SP2108		D255	770mm - No restrictor	
SP2110		C125/160	640mm - No restrictor	
SP2112		C205	760mm - No restrictor	
SP2114		C240	870mm - No restrictor	
SP2513	<b>U/EX Series</b>	All models	850mm Flexible PVC - Cut to size	
SP2620	<b>Ezycool</b>	L110	Feed Pipe - Vertical Unit	
SP2546	<b>Twin Fan</b>	D400/500	Front or Back pump feeder	
SP2116	<b>Mobile</b>	M240	Riser Pipe Kit	







## WATER DISTRIBUTION PARTS - Manifolds etc

Part No.	Manufactured	Model	Description
<b>Solenoids</b>			
SP2057	<b>Old Model</b>		24v Solenoid Retrofit Kit - (Application 240v) Includes 240/24v transformer & solenoid RPE-Filter.
SP2640	<b>2002 - 2009</b> 	Eclipse & Ezycool	24v Solenoid Suits hydraulic drain valve
SP2031	<b>2002 - 2016</b> 	All units (except Twin Fan)	24v Barbed Solenoid Suits units with counter-weight drain valve
SP2013		D400/500 Twin Fan	24v Barbed Solenoid Suits units with counter-weight drain valve
SP2075	<b>1994 - 2000</b> 		24v RPE Solenoid Suits electric drain valve
<b>Accessories</b>			
SP2039			Through Sump Elbow & Bracket Includes O-ring
SP2076			Tap & Filter
SP2140		M240	Flexible connection (braided hose) For mobile with adaptor
SP2145		M240	Outlet Tap - Ball Valve for M240 Mobile Unit
SP2017		M240	90 deg. Barbed Drain Elbow - M240 Mobile Unit
SP2078			Diaphragm - Fluidmaster High Pressure









## WATER DISTRIBUTION PARTS

Part No.	Manufactured	Description	
<b>Pumps and Accessories</b>			
SP2035	<b>2000-2016</b>	M240	Quietflo Pump - Long shaft with support bracket for mobile unit
SP2128		M240	Stainless Steel Pump Support Bracket
SP2010			19mm Restrictor Tap
SP2127			Fasco Pump - While stocks last
SP2380			Super Pump - NEW (replaces SP2127 Fasco pump) clip-on impeller housing for easy cleaning - extra vents so motor runs cooler for longer life
SP2380/16			Superpump Bulk Pack x 16 Pumps
<b>Float Valve and Accessories</b>			
SP2027	<b>1994-2000</b>	CO/CZ MX	Float Valve - Fluidmaster 747
	<b>2001-2002</b>	E Series	
	<b>2001-2016</b>	M240	
			
<b>Water Inlet Control</b>			
SP2210	<b>2000 - 2008</b>		Magnetic Water Level Sensor (MWL) 4 Screw type connectors - suits non-exhaust models
SP2212	<b>2000 - 2016</b>		Magnetic Water Level Sensor (MS) 3 Core cable with single connection to MRU
SP2200	<b>2000 - 2016</b>		Magnetic Float Assembly (MFA) Compatible with MS and MWL sensors

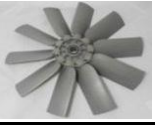
## WATER DISTRIBUTION PARTS - Drain Valves etc

Part No.	Manufactured	Model	Description
<b>Drain Valve and Fittings</b>			
SP2064	<b>Pre 2000</b> 		Hydraulic Drain Valve - Water pressure style
SP2071			Brass adaptor - Suited to hydraulic drain valve
SP2065			Elbow - Screws into top of hydraulic drain valve
SP2069			Elbow - Screws into brass adaptor for hydraulic drain valve
SP2067			6mm pipe - Between hydraulic drain valve and brass adaptor
SP2062		<b>Pre 2000</b>	
SP2066			Square section black "O" ring
SP2068			Round section "O" Ring - To suit 40mm drain
SP2082			Bleed off tray and fitting
SP2072			Drain fitting - female - 40mm
SP2073			Drain fitting adaptor female 40mm to 20mm
SP2040	<b>2001-2016</b> 		Counter-weight drain valve kit - Includes washer, hoses and clips
SP2042			Hose kit - to suit Counter-weight drain valve.
SP2041			Plastic clips - For securing Counter-weight hose - 2 per bag
SP2066C	<b>2001-2016</b>		Counter-weight drain valve washer - Blue square section
SP2131		D400/500 Twin Fan	Hose Kit - Suit Counter-weight drain valve

## FANS AND MOTORS

Part No.	Manufactured	Model	Description
<b>Motors</b>			
SP6012			Motor 600w includes 25uf capacitor kit [collet not included]
SP6014			Motor 750w includes 30uf capacitor kit [collet not included]
SP6015			Motor 1000w includes 30uf capacitor kit [collet not included]
<b>Motor Mounting Ring Non-Shrouded</b>			
SP6022		D400/500 S240, S105	Non-Shrouded Motor Ring
	1994-2016	M240	
	2000-2002	Heritage	
	2000-2006	Cascade	
<b>Fans - Suit Non-Shrouded Motor Rings</b>			
SP6028		1994 - 2000 600w S105	518mm diameter 10 blade - green hub, grey blade - suits 600w motor and S105 units
SP6027		2000 - 2016 600w S105	524mm diameter 10 Blade - green hub, grey blades - suits 600w motor and S105
SP6030		2000 - 2016 750w M200 & S200	524mm diameter 10 Blade - grey hub, grey blades - suits 750w motor, M200 and S200 with 750w motor
SP6072		2000 - 2016 1000w M240 S240	524mm dia 9 blade Powerflow fixed pitch fan, black, includes collet. Suits 1000w, pre-2006 Cascade models, Twin Fan, M240, S240 (replaces SP6031).
<b>Motor Mounting Ring Shrouded</b>			
SP6025		Heritage	Shrouded Motor Ring
	2002-2016		
	2006-2016	Cascade	
<b>Fans - Suit Shrouded Motor Rings</b>			
SP6057		2002-2016 600w	528mm diameter 10 blade variable pitch fan Green hub, balanced, suits 600w motor
SP6058		2002-2016 750w	528mm diameter 10 blade variable pitch fan Grey hub, balanced - suited to 750w motor
SP6059		2002-2016 1000w	528mm diameter 9 blade Powerflow fixed pitch fan Comes with collet assembly, balanced - suited to 1000w motor

## MOTOR PACKS AND ACCESSORIES

Motor Packs			
Part No.	Manufactured		Description
SP6078	2000 - 2016	600w	600w Shrouded motor pack - Includes motor, 10 blade variable pitch fan with green hub, collet assembly and 25uf capacitor kit.
SP6076		750w	750w Shrouded motor pack - Includes motor, 10 blade variable pitch, grey fan, collet assembly, 30uf capacitor and cover.
SP6074	2000 - 2016	1000w	1000w <b>Shrouded</b> motor pack - includes motor, Powerflow fan, collet assembly, 30uf capacitor and cover.
SP6075	2000 - 2016	1000w	1000w <b>Non-shrouded</b> motor pack - Includes motor, Powerflow fan, collet assembly, 30uf capacitor and cover.
Collets			
SP6043	1992 - 2016	600w & 750w	Fan collet & bolt fixing pack to suit 10 blade variable pitch fan. Suitable for 600w & 750w motor/fans. Suits grey fan, grey hub or green hub.
SP6073	2013 - 2016	1000w	Fan collet & bolt fixing pack suits Powerflow 9 blade fixed pitch fan, for 1000w motor. Not compatible with discontinued fan SP6031.
SP6047	2000 - 2013	1000w	DISCONTINUED - Fan collet & bolt fixing pack to suit old 9 blade fixed pitch fan. Not compatible with SP6072 Powerflow fan blade.
Accessories			
SP6020	2000 - 2016		Motor extension lead to electrical box Fitted with 6 pin male connector
SP6070		D400/500	Motor extension lead for twin fan - 1500mm long
SP6062			Motor extension lead plugs male C/W crimps
SP6060			Motor lead plugs female C/W crimps Fits to motor lead
SP6024			Motor mounting grommet kit
SP6048			Motor anchor kit
Capacitors			
SP3039			Capacitor 25uF - includes cover - suits 600w motor
SP3040			Capacitor 30uF - includes cover - suits 750w & 1000w motor
SP3042			Capacitor cover - Fits on electrical box for 25uf & 30uf capacitors











SP6074 Shrouded Type  
Motor Ring



SP6075 Non-Shrouded Type  
Motor Ring

## CIRCUIT BOARDS AND CONTROLLERS











Part No.	Description		
<b>Heritage(D), Cascade (C), A, W &amp; I Series</b>			
SP3000			Modular Roof Board (MRU) circuit board suits QA & QM controller (also use when replacing CO keypad with QA)
SP3221		2005 - 2016	QA 100 speed auto wall controller with bush fire mode
SP3220		2005 - 2016	QM 10 speed manual wall controller
<b>F &amp; FC SERIES</b>			
SP3510			CFRU roof board
SP3506			L Series auto wall controller
SP3504			R Series manual wall controller.
SP3512			Keypad signal booster board
<b>Miscellaneous Electronic Boards</b>			
SP3013	2002 - 2016	M240	PCB Board
SP3007		D500 multi-unit	Multi-Unit Control (MUC) Board - use in place of keypad on additional D500 units when linking multiple units to one keypad. (MUC Board fits inside MRU box)
SP3008		Single Fan Units	Multi-Unit Control (MUC) Board - use in place of keypad on additional units when linking multiple units to one keypad.

## CIRCUIT BOARDS AND CONTROLLERS



Part No.	Description	
<b>Controllers</b>		
	<b>QM CONVERSION KIT</b>	
	<i>Replacement for CM &amp; CF conversion kit</i>	
	Parts making up the conversion kit:	
	Motor Lead	
	Electrical box (Complete with switch, brackets & cable)	
	MRU roof unit	
	QM series keypad	
	Keypad cable	
SP3156		
SP3016		Tek 285 wall controller - while stock lasts
SP3021		TEK 461 LA low voltage roof unit mounted in lid - while stock lasts
SP3005		Neatrol roof unit board
SP0002		QM test keypad - C/W 1 x 1m cable. Suitable for CY/CZ
SP0003		QA test keypad - C/W 1 x 1m cable. Suitable for CR
SP0007		L series test keypad - C/W 1 x 1m cable
SP0006		R series test controller - c/w 1 x 1m cable
<b>Multi-Core Control Cables</b>		
SP5200		MRU to keypad cable - 15m x 7 core with two female connectors 12m.
SP5206		MRU to keypad extension cable - 10m x 7 core with 1 male and 1 female connector
SP5216		MRU extension cable - 200mm long 1 x male pin and 1 x female connector
SP5224		MRU to Multi-Unit Control(MUC) Board Cable for D500 - 250mm long 7 core x 2 x female connector
SP5223		MRU to MRU Board connector cable for D500 unit - 3.2m long 7 Core x 2 x Female connector
SP5218		Test Keypad cable - 1m x 7 Core cable w/2 female connectors
<b>Electrical Box &amp; Accessories</b>		
SP3045	<b>2000 - 2016</b>	MRU electrical box and lid -cable bracket & isolator switch. Suits down, top & side discharge units
SP3198	<b>2000 - 2016</b>	MRU electrical box isolator switch Suits down, top & side discharge units
SP3530	<b>2003 - 2016</b>	CFRU Electrical box and lid cable bracket and isolator switch, suits down, top & side discharge units
SP3051	<b>2006 - 2016 M240</b>	Electrical box and lid - New type no on/off switch. Holes drilled for switch knobs. For replacment of electrical boxes in units manufactured before 2007, new type side panels will have to be fitted.
SP3053	<b>All Units</b>	Black Plastic bolt M6x25mm - Pack of 4
SP3242		7 pin in-line spike filter
SP3052		Fuse 5 amp slow blow - packs of 5
SP3058		Fuse 15 amp slow blow - packs of 5



## ZONE CONTROL SYSTEM SPARES

Part No.	Description	
<b>Zone Control</b>		
SP3700	 CoolBreeze Zone Control System Zone Control Board & Keypad (sold as a pair only)	
SP3709	 Comfort Control System (Connectair) - 8 Zone Digital Keypad	
SP3710	 Comfort Control System (Connectair) - 8 Zone Main Control Box	
SP3714	 Energy Wise (Connectair) - 6 Zone Manual Keypad	
SP3715	 Energy Wise (Connectair) - 6 Zone Main Control Box	
<b>Cables and Accessories</b>		
SP3716		240 - 24 Volt transformer
SP3712	CCS	Comfort control zone sensor 6m
SP3713	CCS	Comfort control duct sensor
SP3707	Ezyzone	Control Cable - 30m
SP3708	Ezyzone	Comfort AC power cable
<b>Damper Motors</b>		
SP6065	 24v Damper motor - WHITE - includes adaptor kit. Screws onto damper, also suitable for Ezyzone systems, uses 3 core cable	
SP6066	 240v Damper motor - BLUE - Screws onto damper - 3 core cable.	
SP6068	 24v Damper motor - WHITE - Cable fitted with RJ connector, Ezyzone screw fit	
SP6069	 24v Comfort control damper motor GREY - suits Fast Fit dampers	
SP6071	 240v Comfort control damper motor YELLOW - suits Fast Fit dampers click fit - 3 core cable	

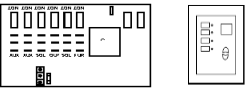
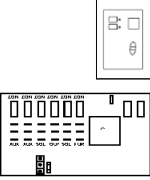
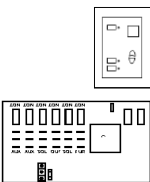

## SOLECTAIR, SOLECTAIR PLUS & SOLECTAIR UNO

Part No.	Description	
<b>Circuit Boards and Controllers</b>		
SP3005		Solectair speed control PCB (Neatrol) Fitted to evaporative air conditioner
SP3076		Solectair MCU Fitted to evaporative air conditioner
SP3070		Solectair wall controller Fitted to evaporative air conditioner
SP3078		Solectair plus main control board (ZCRU) Fitted to Omega gas furnace Keypad and roof unit sold as a pair
SP3075		Solectair Plus 2 Button auto operation Fitted to Omega gas furnace Solectair Plus main control board (ZCRU) Fitted to Omega gas furnace Keypad and roof unit sold as a pair
SP3701		Solectair Uno keypad 2 button auto operation  Solectair Uno main control system board (ZCRUU) Fitted to stand alone system

## SOLECTAIR, SOLECTAIR PLUS & SOLECTAIR UNO

Part No.		Description	
<b>Electrical Components and Accessories</b>			
SP3074		Solectair - speed pot - C/W leads	
SP3080		Solectair - speed control electrical box top & base - C/W cable bracket & brass fitting bolts, C/W blank serial number sticker	
SP3084		Solectair - MCU electrical box top & base - C/W switch, cable, bracket & circuit diagram & C/W connector strip	
SP3030		Solectair - Isolator knob	
SP3031		Mains lead - 3m, fitted to all electrical boxes	
SP5232		Solectair - control cable - 20m, 5 pin, 2 female ends - fitted to Solectair	
SP5227		Solectair - control extension cable - 20m, 5 pin, 1 female & 1 male connector	
SP5222		Solectair Plus & Solectair Uno - control cable - 10m x 8 core, 2 female connectors	
SP5220		Solectair Plus & Solectair Uno - Temperature sensor cable 12 x 3 core, 1 female connector and 1 temperature sensor	
<b>Cowling and Filter</b>			
SP6080		Solectair - Inlet cowling - C/W non-shrouded motor ring (UCHTSMS)	
SP6082		Solectair - Inlet grill - (UCHTSMG)	
SP9020		Solectair - filter - C/W rim - (UCHTSF)	
SP9021		Solectair Uno - disposable filter - 360x360x100 (PHRF)	
SP9606		Non return collapsible damper	
<b>Motors and Accessories</b>			
SP6012		Solectair - motor 600w	
SP6020		Solectair - motor lead to electrical box extension	
SP6024		Solectair - motor mounting grommet kit	
SP9607		Solectair Uno - damper motor, 24v, yellow	
SP9608		Solectair Uno - EBM motor, 230v 50hz	
<b>Fan and Accessories</b>			
SP6027		524mm diameter 10 blade variable pitch fan - Green hub for 600w motor	
SP6046		Fan collet & bolt fixing pack - To suit 10 blade variable pitch fan above	

## MISCELLANEOUS ACCESSORIES

Part No.	Manufactured	Model	Description	
<b>Vent Clips and Mobile Accessories</b>				
SP9002	<b>1994-2010</b>	All Models	Quietflo grille clip - per bag of 4	
				
SP9001	<b>2004-2015</b>	All Models	Ezyvent grille clip - per bag of 4	
				
<b>M240 Mobile Frame Parts</b>				
SP9604	<b>2002-2016</b>	M240	Mobile wheel with brake	
SP9605	<b>2002-2016</b>	M240	Mobile Wheel without brake	
SP9609	<b>2002-2016</b>	M240	Mobile grille - blue	
SP9610	<b>2002-2016</b>	M241	M240 Mobile Frame, P/Coated, c/w Wheels	
SP9611	<b>2002-2016</b>	M242	M240 Mobile Frame, P/Coated, w/o Wheels	

**EXPLODED VIEW DOWN DISCHARGE HERITAGE AIR CONDITIONING UNIT**

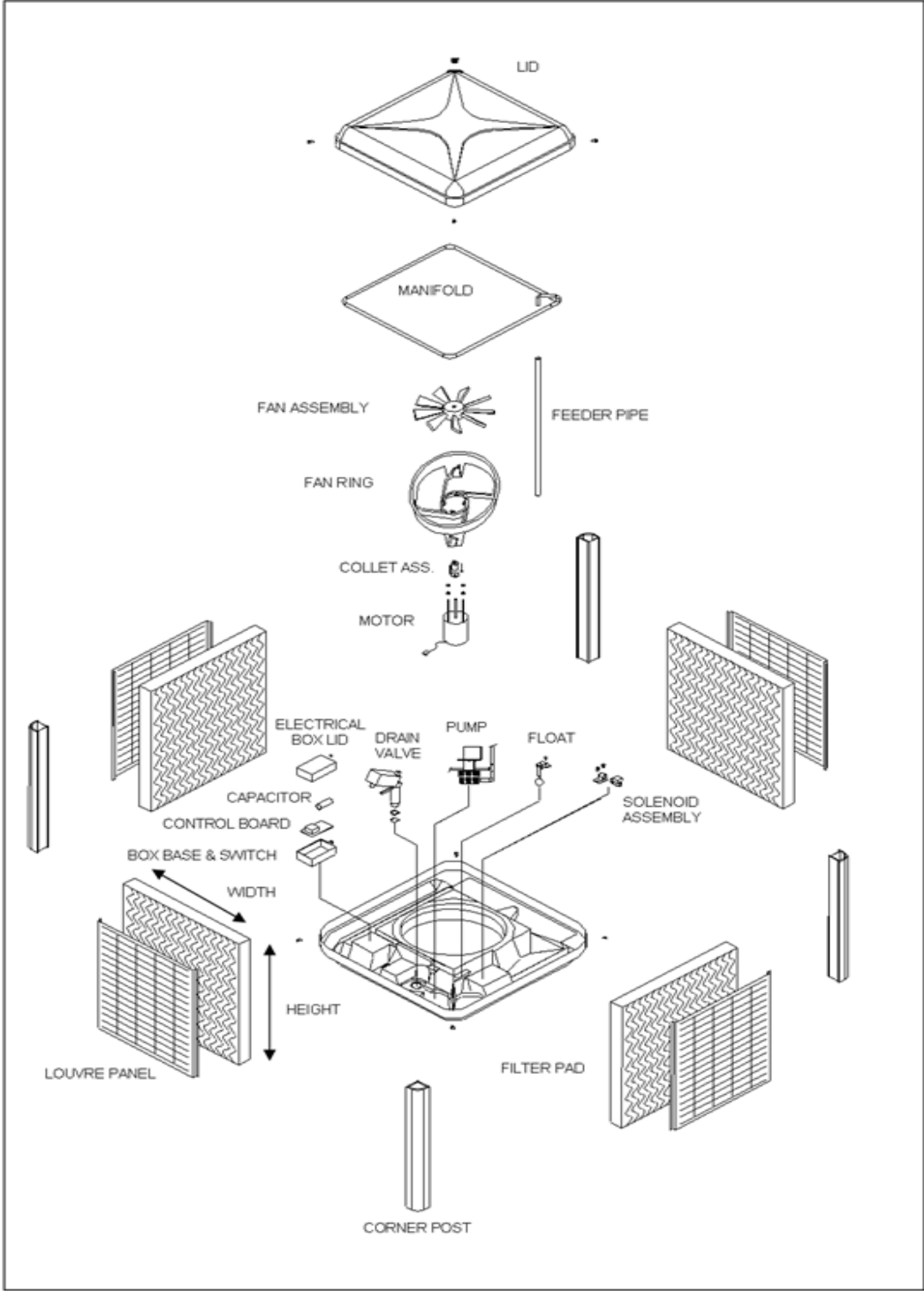

**EXPLODED VIEW DOWN DISCHARGE CASCADE AIR CONDITIONING UNIT**

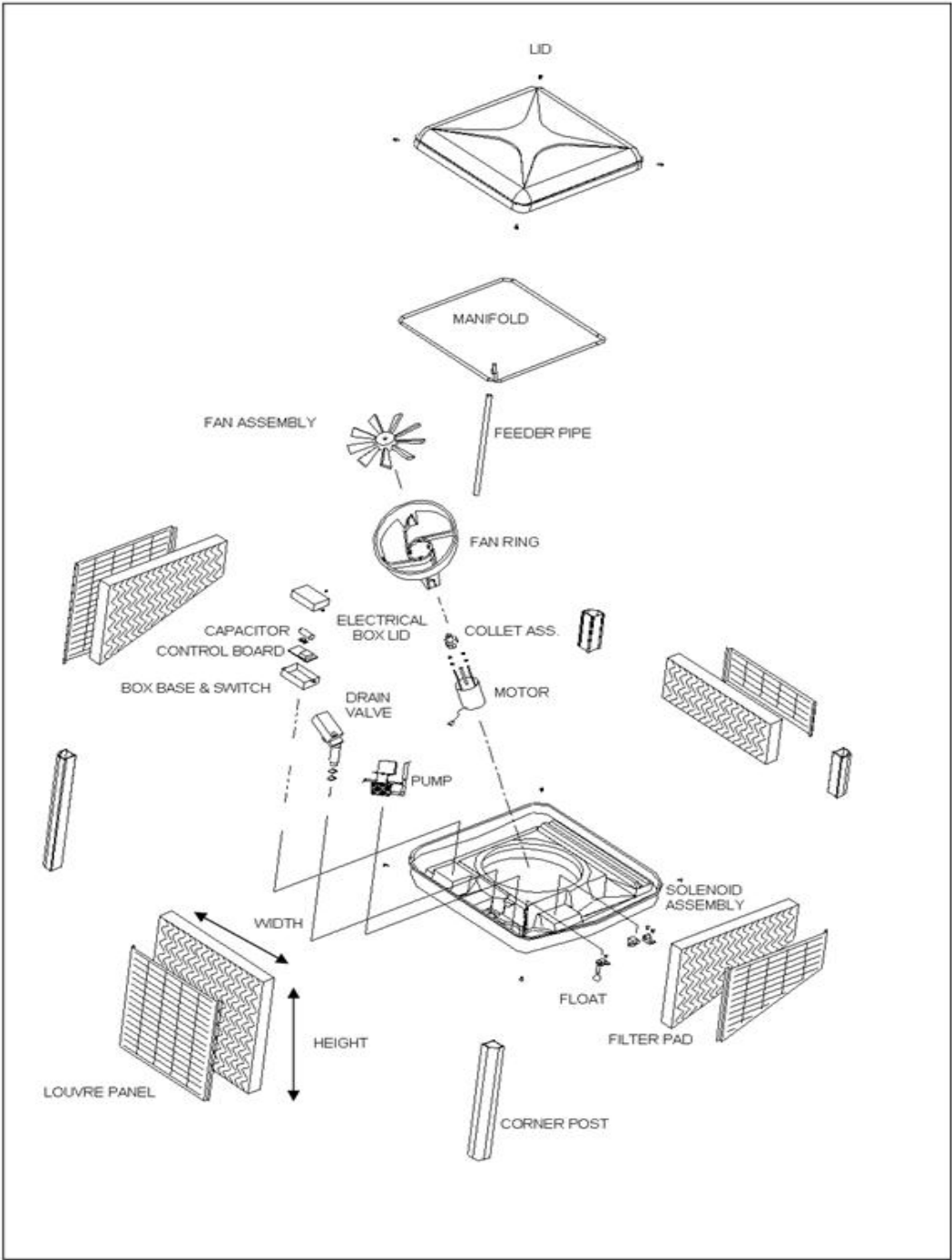

**EXPLODED VIEW TWIN FAN DOWN DISCHARGE (D500) AIR CONDITIONING UNIT**

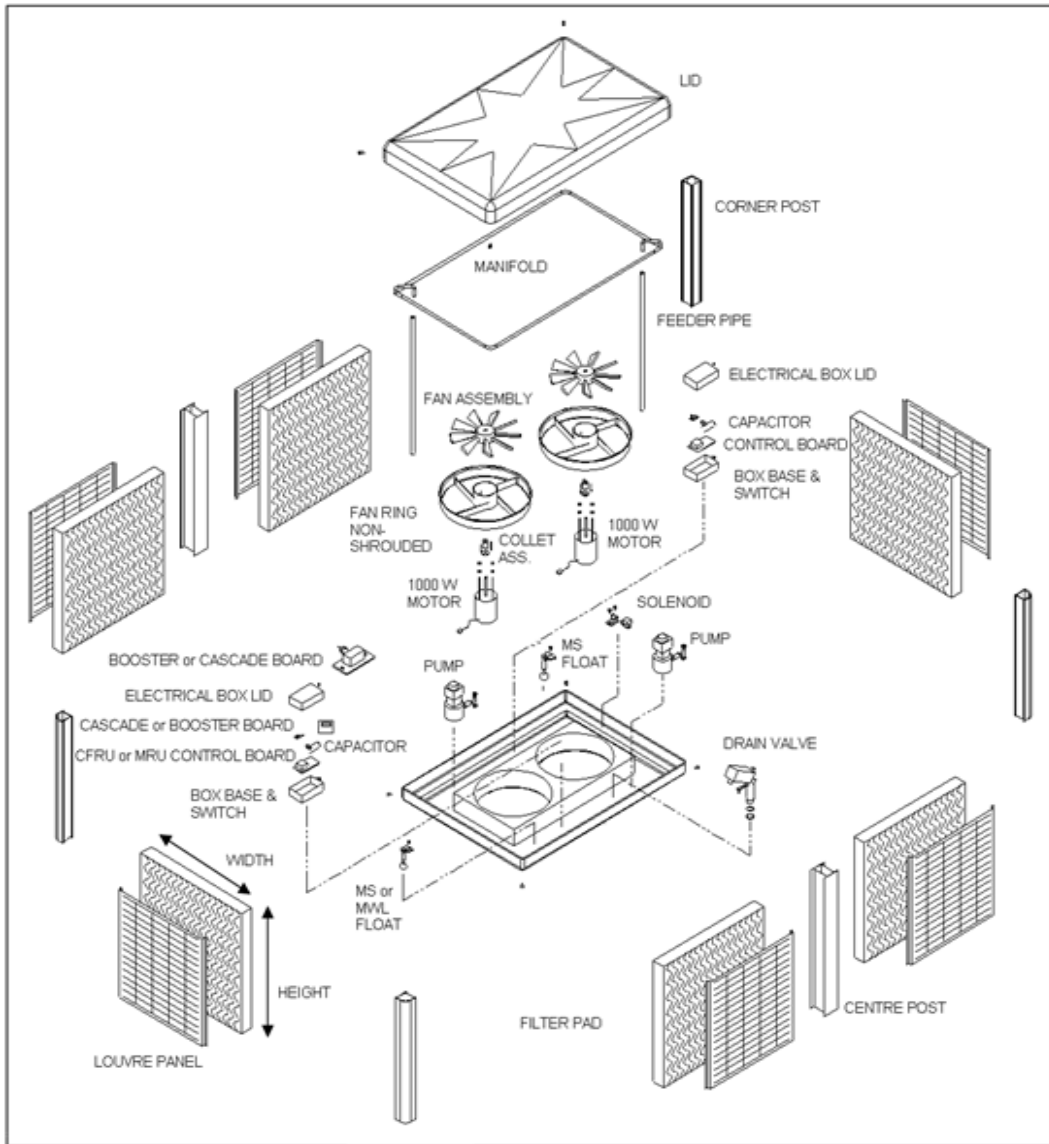

QAD500 SERIES	FD500 SERIES
QA KEYPAD 	R KEYPAD 
Roof Unit = MRU	Roof Unit = CFRU
Signal Amplification = Cascade PCB 	Signal Amplification = Booster PCB 
250mm Cascade Board to MRU connecting cable	No connecting cable required
Water Inlet = MS Float x 2	Water inlet = MVL Float x 1

**EXPLODED VIEW SIDE DISCHARGE S105 AIR CONDITIONING UNIT**

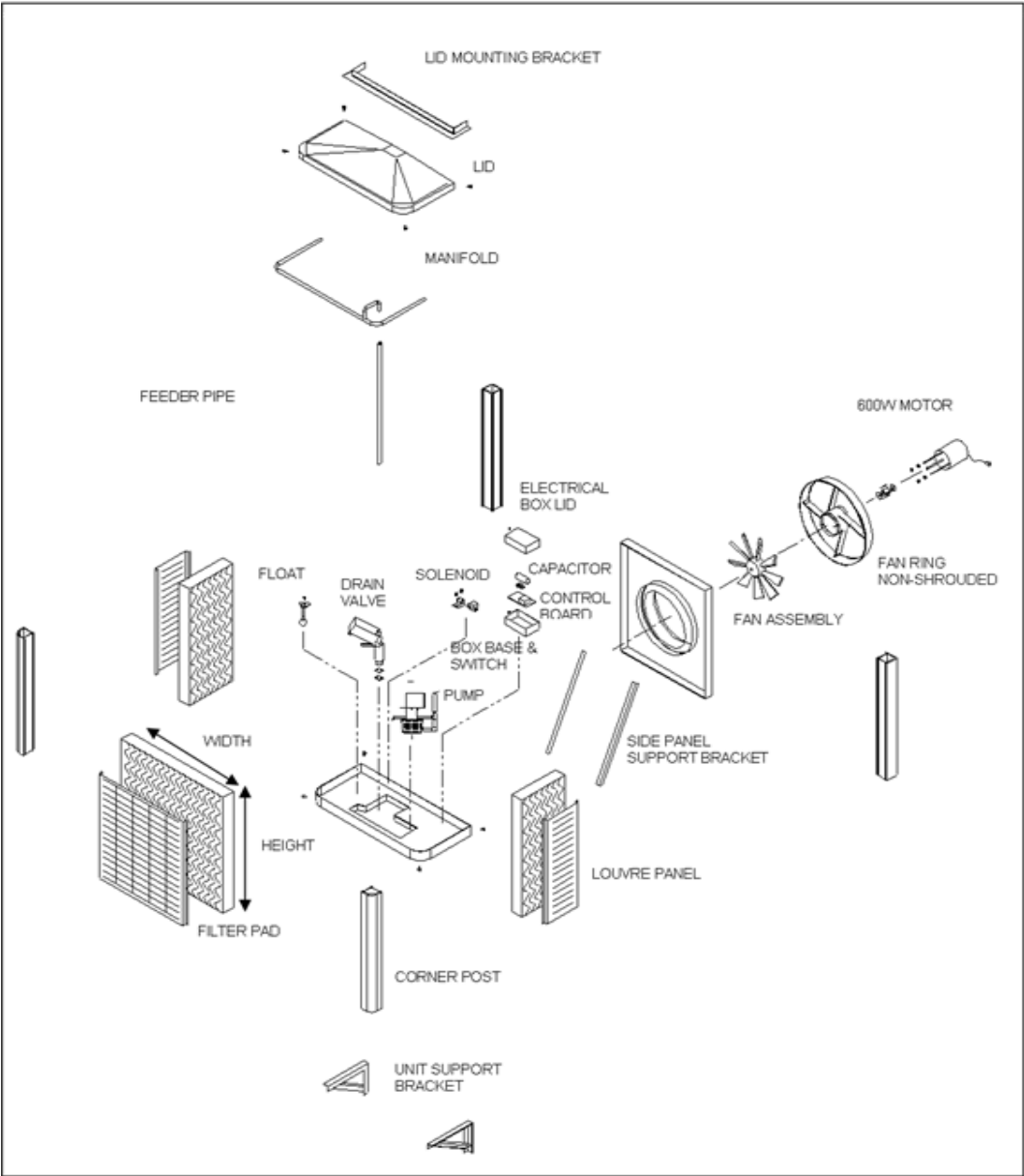



EXPLODED VIEW SIDE DISCHARGE S240 AIR CONDITIONING UNIT

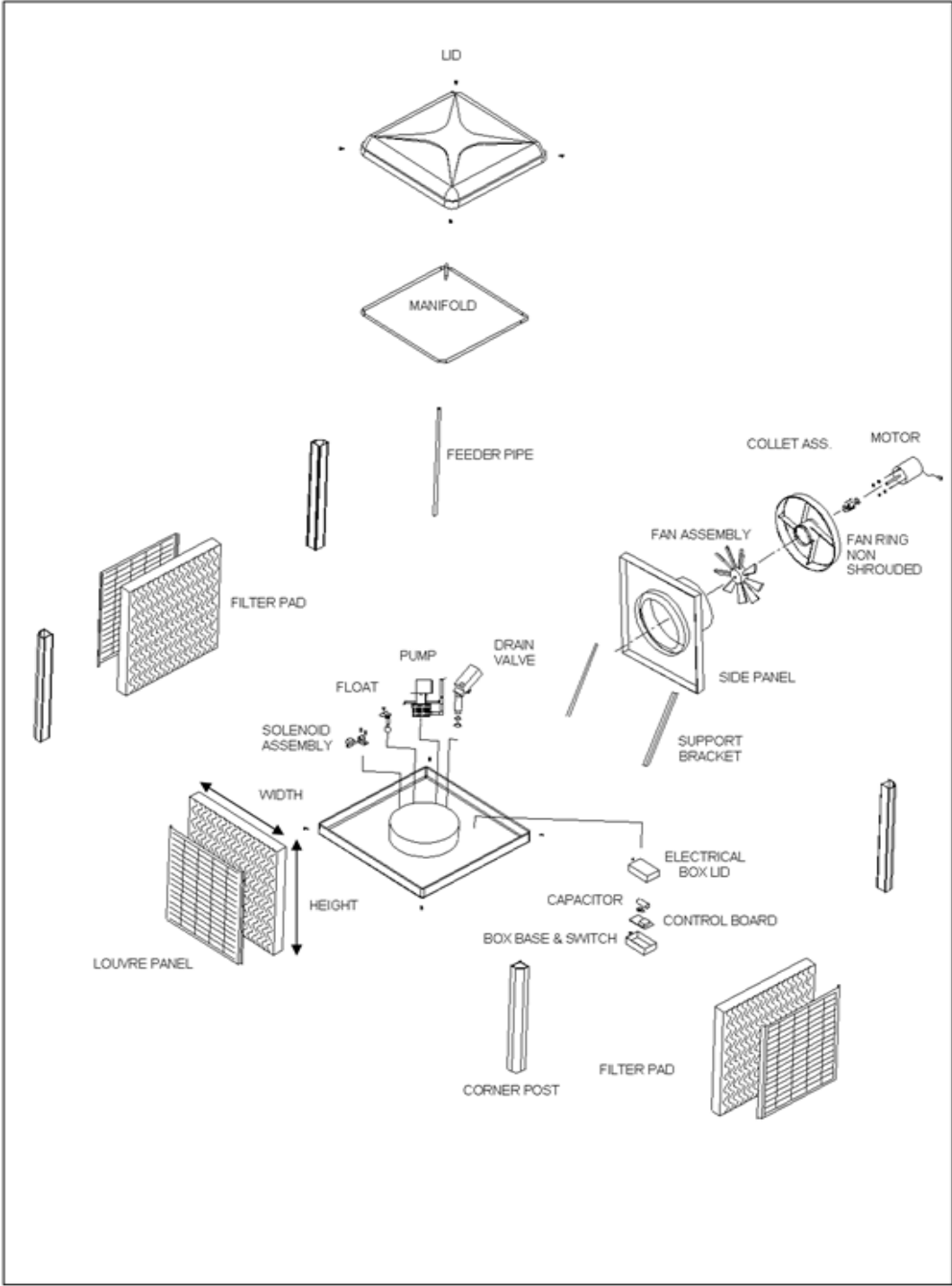

**EXPLODED VIEW MOBILE (M240) AIR CONDITIONING UNIT**

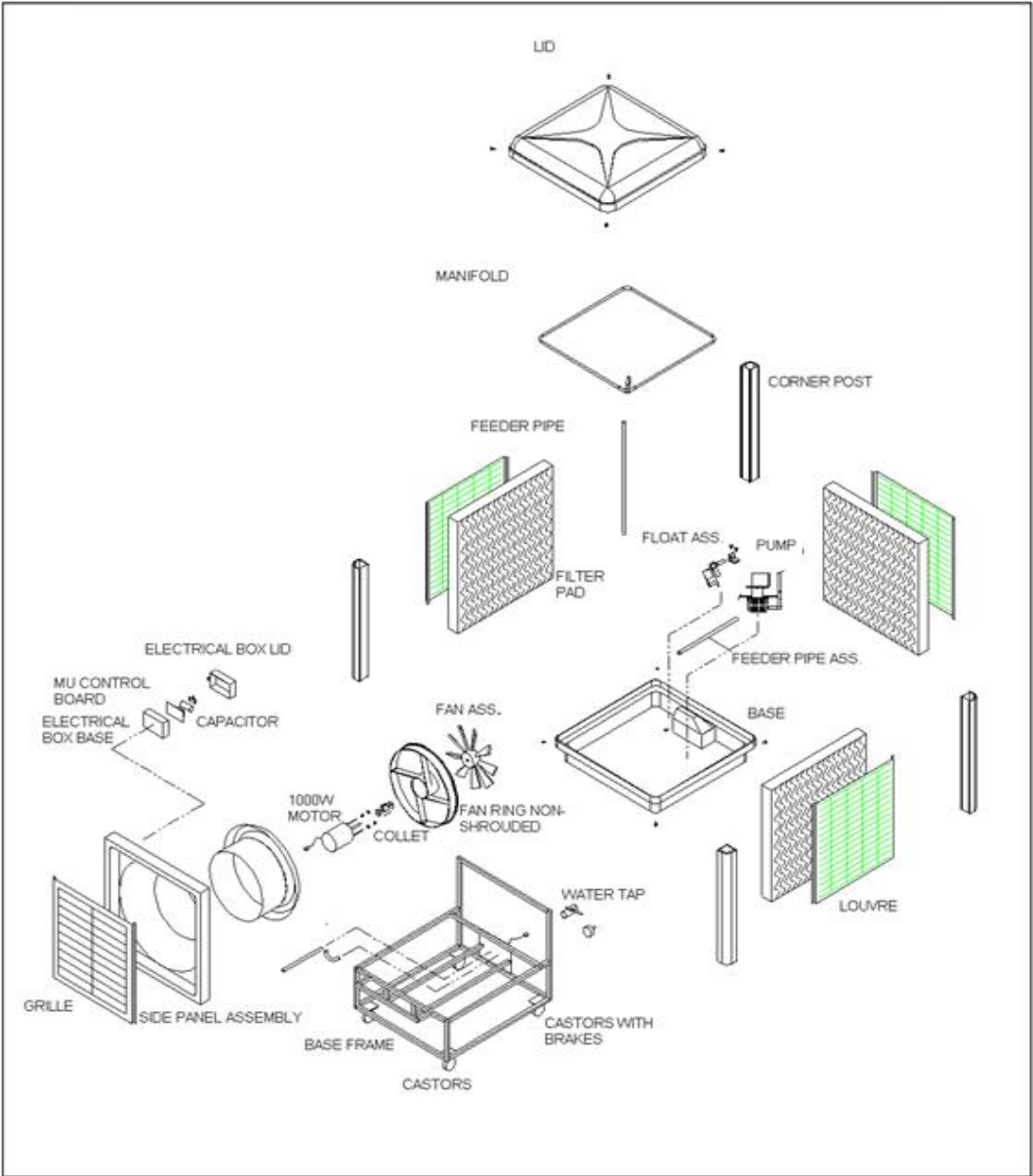

## UNIT COLOURS AVAILABLE



Colour Codes: Y = Grey, R = Red, B = Beige, N = Green, E = Black

## CONTROLLERS

### QA AUTO CONTROLLER



Replaces CO & CR Controller

### QM MANUAL CONTROLLER



Replaces CA, CY & CZ controllers

### L SERIES AUTO CONTROL



### R Series MANUAL CONTROLLER



Replaces Twin R controller



**VICTORIA:** 5 Hawker Street, Airport West 3042 Ph: 03 8336 1042 Fx: 03 9310 3043  
**WESTERN AUSTRALIA:** 28 Division Street Welshpool 6106 Ph: 08 9350 2215 Fx 08 9353 4225