

ARENA 2 + 4 ZONE CONTROLLER

USER INSTRUCTIONS

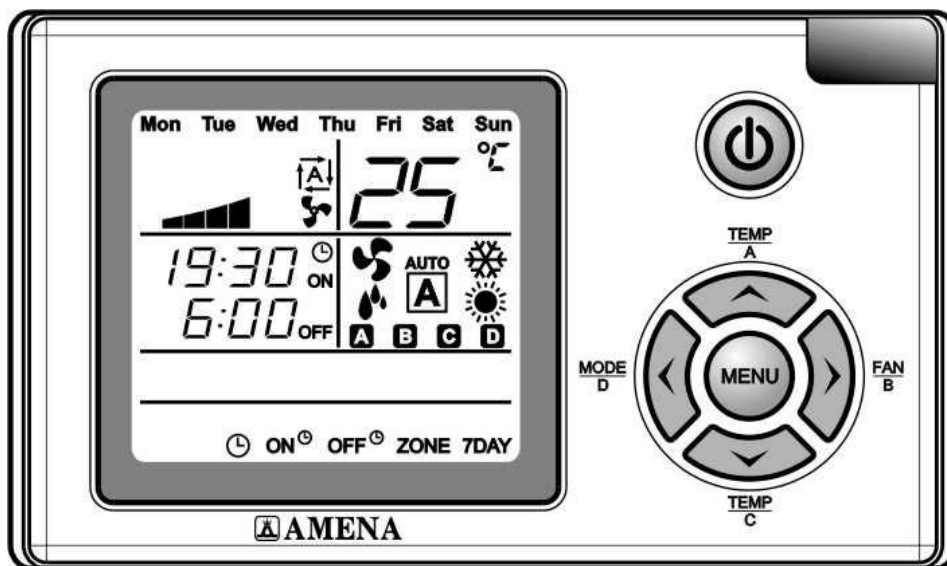

2 ZONE



4 ZONE

USERS FEATURES	2 ZONE	3
Power On/Off		3
Auto Mode		3
Zone Control		3
Operating mode		3
Room Temperature reading (T_{room})	2 ZONE	4
Fan		4
Cool		4
Dry		4
Timer on	2 ZONE	5
Timer off		5
SYSTEM FEATURES	2 ZONE	6
Watchdog		6
Compressor delay protection		6
Compressor minimum on time		6
Non-volatile memory		6
Freeze (Anti-ice) function		6
Defrost Function	2 ZONE	7
Heat Fail	2 ZONE	8
Error Display		8
CONCLUSION OF FEATURES		8
INTRODUCTION	4 ZONE	9
USER'S FEATURES	4 ZONE	10
Power On/Off		10
Fan speed		10
Operating mode		10
Temperature Setting		10
Zone control	4 ZONE	11
Enhanced features		11
Enter into Menu		11
Clock setting		11
Timer on		11
Timer off		11
Zone control		11
7 Day program		11
SYSTEM FEATURES	4 ZONE	12
While defrost		12
Defrost ends		12
Reading temperature sensors	4 ZONE	13
Offset temperature		13
Error display		13
CHECKING BEFORE CALLING THE SERVICE MAN – OPERATION INSTRUCTIONS		14

The Following features can be operated by the buttons on the Display unit.

Power On/Off

Press  button will turn on the air conditioner or vice versa. When turned on, it will operate according to the setting shown on the Display unit. The ZONE LED on the Display unit will show the status of the zone operation.

Fan

Press  to select the fan speed (high, medium, low or auto speed).

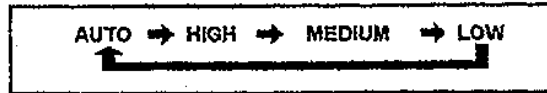

Auto Mode

When the fan speed is put in auto speed, the speed will be adjusted automatically according to the difference between the room temperature and set temperature.

- If the difference is 3°C or more, the speed is high.
- If the difference is 2°C, the speed is medium.
- If the difference is 1°C or less, the speed is low.

Note: The  button cannot be used in DRY mode.

Zone Control

ZONE buttons are used to turn on/off the damper. Jumper at OP5 is for selection of the following algorithm.

- a) Jumper OP5 is **not** inserted: While only one zone is activated then that ZONE button is pressed (both zones are turned off), the system will delay for 2 minutes and then turn off the operation. All LED will blink as an alarm signal. During this delayed period if any ZONE button is pressed, the system will turn on the zone damper.
- b) Jumper OP5 is inserted: There will be no protection and alarm as per above. If both zones are turned off, the system will follow the command.

Operating mode

By pressing MODE button, the air conditioner can be put in

- 3 operating modes (fan, cool, dry) if the COOL version is ordered.

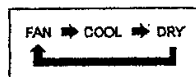

- 5 operating modes (fan, cool, dry, heat, auto) if the HEAT/COOL version is ordered.

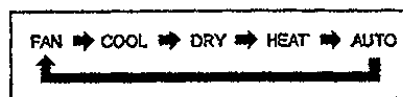

Room Temperature reading (T_{room})

2 ZONE

There are 2 room temperature sensors. One is installed at the return air point of Fan Coil Unit. Another is at the Display unit. Jumper at OP2 is for selection of the following algorithm.

- Jumper OP2 is **not** inserted. The room temperature will be read from only the sensor at return air point for all modes of operation.
- Jumper OP2 is inserted: In COOL or DRY operation, the room temperature will be read from the sensor at the return air point of FCU. In HEAT operation, the room temperature will be read from the sensor at the Display unit. When any one of the sensors have failed (short/open circuit), the temperature will be read from another sensor.

Fan

The system will operate as Fan only. The SLEEP, TEMP ▲ and TEMP ▼ buttons are not used.

Cool

The system will operate as the cooling unit. The compressor will

- Operate if $T_{room} \geq T_{set} + 1$
- Stop if $T_{room} \leq T_{set}$

However, the compressor is subjected to a 3-minute delay protection each time it stops.

Dry

The system will operate as the Dehumidifier.

- Define T_s = setting temperature
- T_r = room temperature

Zone A is the area where $T_r - T_s \geq 2^\circ\text{C}$

Zone B is the area where $0^\circ\text{C} \leq T_r - T_s < 1^\circ\text{C}$

Zone C is the area where $-2^\circ\text{C} \leq T_r - T_s < -1^\circ\text{C}$

Zone D is the area where $T_r - T_s \leq -4^\circ\text{C}$

Other temperature rang is called **dead band**. Which the system is considered to be in the previous zone.

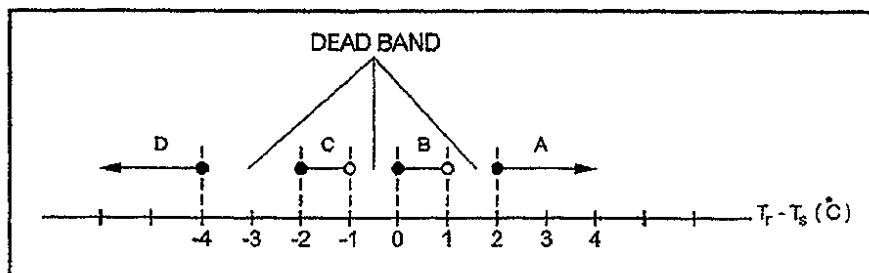

Timer on

2 ZONE

The airconditioner can be programmed to turn on in advance.

- Press START button, start time will blink,
- Press HR button to set the hour,
- Press MIN button to set the time,
- Press START button again, to confirm

To cancel this function, press START button again.

Timer off

The air conditioner can be programmed to turn off in advance.

- Press STOP button, stop time will blink,
- Press HOUR button to set the hour,
- Press MIN button to set the minute,
- Press STOP button again, to confirm.

To cancel this function, press STOP button again.

Watchdog

There is a watchdog circuit to watch the operation of the microprocessor. If it has malfunctioned, this circuit will reset the microprocessor automatically.

Compressor delay protection

Each time the compressor is off, there will always be a 3 minute time delay before the compressor can restart. In case of power interruption, the system will delay the operation of the compressor in the range of 3-4 minutes in random order. This is to prevent more than one compressor starting at the same time as another, saving the powerboard from 'overloading'.

Compressor minimum on time

Once the compressor starts, it will operate at least 24 seconds.

Non-volatile memory

The system keeps the setting parameters such as on/off status, fan speed, etc. in its non-volatile memory. If there is a power interruption and back to normal, the control will automatically resume its operation with the same setting parameters (except the sleep and timer function which will be cancelled.)

If there is any change in the parameter, it will be saved in the non-volatile memory 5 seconds later.

Freeze (Anti-ice) function

In COOL or DRY mode, there is a feature to prevent the evaporator from freezing.

Enter into Freeze process	While in Freeze process	Exit from Freeze process
T _{indoor coil} ≤ 0°C, and	Comp. stops, and	T _{indoor coil} ≥ 7°C, or
Comp. runs continuously more than 10 min.	Indoor fan at low speed, and	System OFF
	There will be an alarm signal at the Display unit.	

Defrost Function

2 ZONE

In HEAT mode if the outdoor coil temperature is very low and there is ice formed on the coil. The air conditioner cannot operate efficiently and the compressor may be damaged. The defrost function will be activated, it will reverse the system's mode operation from heat to cool. The heat will be transferred from the indoor unit to the outdoor coil. Meanwhile the indoor fan will be stopped to protect the user in the room from the cold draught.

As soon as the outdoor coil temperature is below 3°C , the defrost timer starts. If the temperature is above 3°C more than 2 minutes, the timer is reset.

The defrost process is activated if

- a) The compressor has been running continuously more than 5 minutes and the system is put in heat mode.
- b) The defrost timer time meets one of the below conditions
 - The outdoor coil temperature is decreased from $+3$ to -8°C (line AB) during 30-60 minutes and remains at -8°C or below, more than 5 minutes.
 - The outdoor coil temperature is reduced from $+3$ to -4°C (line AC) during 60-120 minutes and remains at -4°C or below, more than 5 minutes.
 - The outdoor coil temperature is reduced from $+3$ to -2°C (line AD) after 120 minutes and remains at -2°C or below, more than 5 minutes.

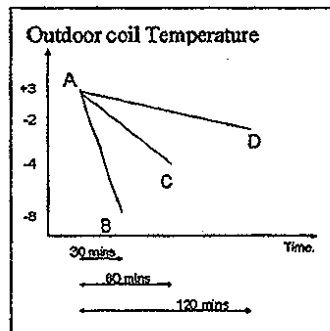

While the defrost function is activated,

- The indoor fan stops and
- The outdoor fan stops while the compressor runs and
- The reversing valve is not energized (running in cool mode) and
- The LED on the display unit blinks.

The system will go back to the normal stage if

- The outdoor coil temperature is above 30°C or
- The defrost function operates more than 10 minutes or
- The air conditioner is turned off.

In COOL or DRY mode if the compressor has been operating more than 3 minutes but the indoor coil temperature is still above 25°C , the compressor has failed. The controller will send the alarm by blinking LED on the display.

To exit is by turning off the air conditioner or changing the mode of operation of Fan or Heat.

Heat Fail

2 ZONE

In HEAT mode and not in the Defrost status if the compressor has been operating more than the 3 minutes but the indoor coil temperature is still below 25°C, the compressor has failed. The controller will send the alarm by blinking LED on the display.

To exit is by turning off the air conditioner or changing the mode of operation.

Error Display

When there is any error, there will be an alarm on the Display unit as follows:

Alarm signal	Description
Zone 1 LED blinks with signal as per Fig. A	Freeze or Defrost function is activated.
Zone 1 LED blinks with signal as per Fig. B	Cooling or Heating fail function is activated.
Timer LED blinks with signal as per Fig. A	Room or Freeze or Defrost sensor's error
Timer LED blinks with signal as per Fig. B	Compressor overload or Anti-overheat function is activated
All LED blink with signal as per Fig. A	System operation is stopped due to both zone dampers are turned off.

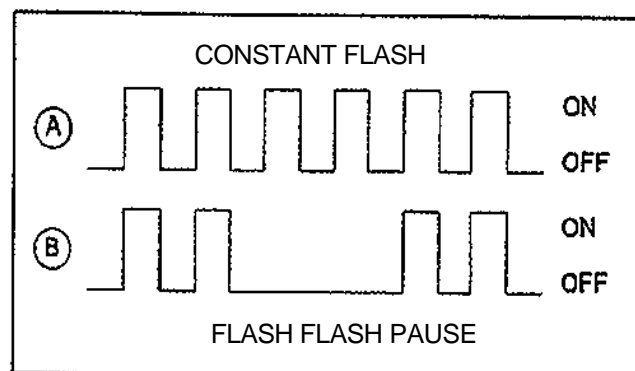

CONCLUSION OF FEATURES

PAGE #	DESCRIPTION	LCD WIRED COOL	LCD WIRED HEAT
Page 3	Users Features		
Page 3	Power On/Off	●	●
Page 3	Fan	●	●
Page 3	Zone Control	●	●
Page 3	Operating Mode		
Page 10	Temperature setting	●	●

Amena 4 Zone control II is a two piece fan coil thermostat available for Cool only & Heat/Cool versions. Its application is for the duct type system which can control up to 4 zone dampers. The system consists of

- Main unit
- Display unit (which up to 2 units can be used).
- External transformer
- Cable 2 cores, 10M connected between Main & Display units.
- Remote unit with mounting bracket (optional)

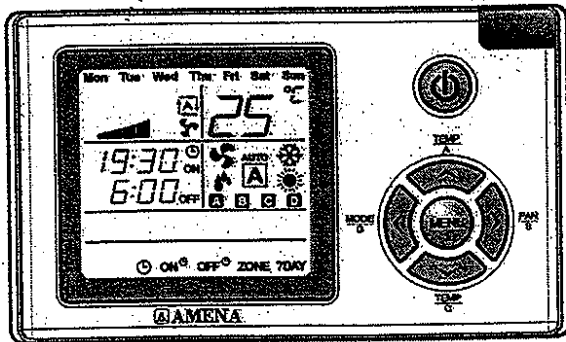

Display unit

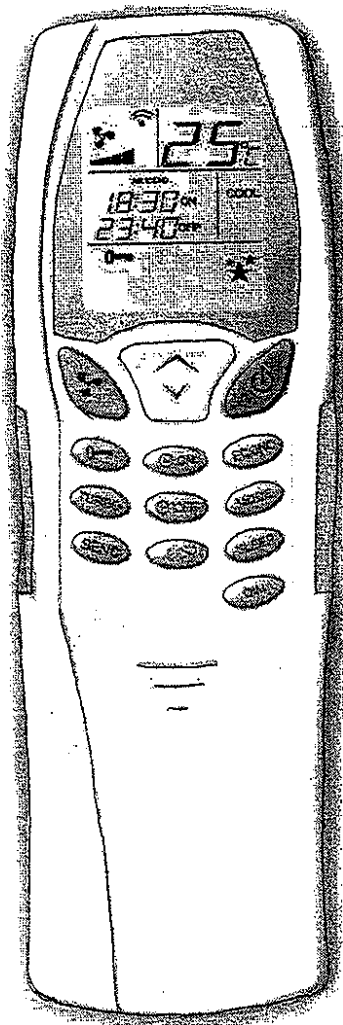

Remote unit

USER'S FEATURES

4 ZONE

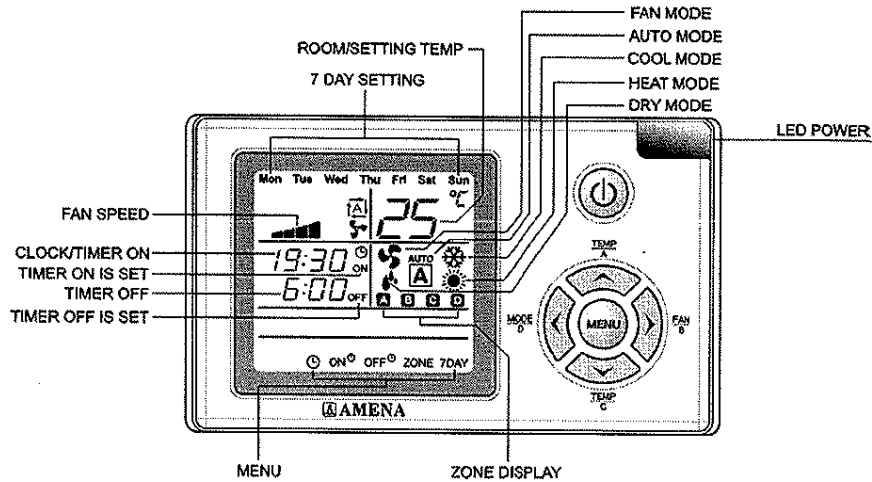

Power On/Off

Press  button to turn/off the system.

Fan speed

Press FAN button to set fan speed (turbo, high, medium, low or auto). In auto mode the speed will be changed automatically according to the difference between T_{room} & T_{set} (ρT)

ρT	Speed
$\geq 3^{\circ}\text{C}$	high
$= 2^{\circ}\text{C}$	medium
$\leq 1^{\circ}\text{C}$	low

Operating mode

By pressing MODE button, the air conditioner can be put in

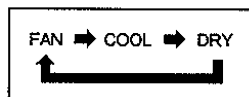

- 3 modes (fan, cool, dry) if the COOL version is ordered.



- 5 operating modes (fan, cool, dry, heat, auto) if the HEAT/COOL version is ordered.

NOTE: If HEAT/COOL version is used for Cool only application, the Jumper setting shall be done.

Temperature Setting

Press  or  button to set the temperature in a range of 18-30°C.

Zone control

4 ZONE

To turn On/Off the zone dampers:

- Press & hold MENU button for 2 seconds, Display shows ZONE.
- Press A, B, C or D button(s) to turn on/off any particular zone(s), Display shows the active zone(s).

Note: To exit press the MENU button again or if no button is pressed exit occurs within 15 seconds.

Enhanced features

Following is an enhanced features instruction that the user has to enter into Menu window.

Enter into Menu

- Press MENU button to display the menu. Using ◀ or ▶ button to move the cursor.

Clock setting

- Move cursor to ⌚ position and then press MENU button.
- Press ▲ or ▼ button for Hour setting.
- Use ◀ or ▶ button to enter the Minute setting and then press ▲ or ▼ button for setting.
- Use ▶ to enter the Day setting and then press ▲ or ▼ button for setting.

Note: If Timer on/off is set, there will be no Clock display.

Timer on

- Move cursor to ON ⌚ position and then press MENU button.
- Press ▲ or ▼ button for HOUR setting.
- Use ◀ or ▶ button to enter the MINUTE setting and then press ▲ or ▼ button to set.

Note: To cancel is by pressing POWER button while in this setting mode.

Timer off

- Move cursor to OFF ⌚ position and then press MENU button.
- Press ▲ or ▼ button for HOUR setting.
- Use ◀ or ▶ button to enter the Minute setting and then press ▲ or ▼ button to set.

Note: To cancel press POWER button while in setting mode.

Zone control

- Move cursor to ZONE position and then press MENU button.
- Press A, B, C or D button(s) to turn on/off any particular zone(s), Display shows the active zone(s).

7 Day program

The system can be programmed to turn on/off 5 + 2 or 7 day basis.

- Move cursor to 7 DAY position and then press MENU button.
- Use ◀ or ▶ button to select 5, 2 or 7 day setting and then press MENU button.

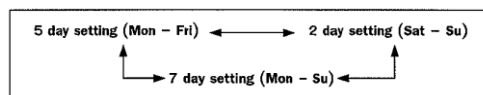

- Use ◀ or ▶ button to enter the Timer on/off, Hour/Minute setting and then press ▲ or ▼ button for setting.

Note: - If 7 Day program's Timer on/off is set, the LCD shows "7 DAY".

- To cancel press the POWER button while Timer on/off 7 Day program mode. The LCD does not show "7 DAY".

- To override is by pressing ▼ button at the same time. The LCD shows "7 DAY" is blinking.

- To deactivate the override press the ▼ button at the same time.

Watchdog : There is a watchdog circuit to reset the MCU if it malfunctions due to voltage fluctuation or other abnormality.

Compressor delay protection : There is a 3 minute delay time for the compressor to restart. However in case of power interruption the compressor can be restarted in a range of 3-4 minutes in random order.

Compressor minimum on time : If T_{room} reaches T_{set} but the compressor operates less than 3 minutes, it will continuously operate up to 3 minutes.

Auto restart : In case of power interruption and back to normal, the control will automatically resume its operation with same settings.

Freeze protection : In Cool or Dry mode if $T_{indoor\ coil} \leq 3^{\circ}C$ and Compressor runs continuously more than 10 minutes, this function will be activated. It will stop the compressor, and runs the fan at low speed.

The system will resume its normal operation if $T_{indoor\ coil} \geq 7^{\circ}C$ or the system is turned off.

Defrost function : In HEAT mode if $T_{outdoor\ coil}$ is very low, the compressor cannot operate efficiently. This function will be activated to protect the compressor.

Defrost process

As soon as $T_{outdoor\ coil} < 3^{\circ}C$, Defrost timer starts. If $T_{outdoor\ coil}$ is above $20^{\circ}C$ for more than 2 minutes, Defrost timer will reset.

The Defrost function is activated if:

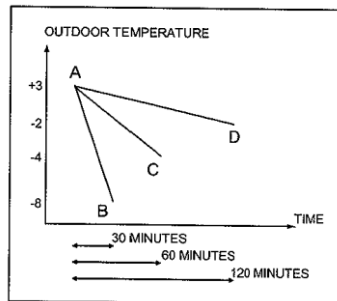

- a) Compressor has been running continuously in heat mode for more than 5 minutes, and
- b) Defrost timer meets one of the below conditions
 - $T_{outdoor\ coil}$ falls from +3 to $-8^{\circ}C$ (line AB) during 30-60 minutes and remains $\leq -8^{\circ}C$ more than 5 minutes.
 - $T_{outdoor\ coil}$ falls from +3 to $-4^{\circ}C$ (line AC) during 60-120 minutes and remains $\leq -4^{\circ}C$ more than 5 minutes.
 - $T_{outdoor\ coil}$ falls from +3 to $-2^{\circ}C$ (line AD) after 120 minutes and remains $\leq -2^{\circ}C$ more than 5 minutes.

While defrost

The indoor & outdoor fans stop while the compressor operates in Cool mode.

Defrost ends

If $T_{outdoor\ coil}$ is above $14^{\circ}C$ or Defrost function operates more than 10 minutes, the system will return to heat mode automatically.

Reading temperature sensors

4 ZONE

Both Main & Display units are equipped with room temperature sensors.

- In Cool mode, the reading temperature is from Main unit's sensor or Display unit's sensor can be selected by Jumper at connector P21.
- In Heat mode, the reading temperature is from Display unit's sensor.
- If two Display units are installed the reading temperature will be either
 - a) The average value of two readings, or
 - b) From the last Display unit which the button is pressedThis option can be selected by Jumper OP4 on Main unit.

Offset temperature

In heat mode, the offset for room temperature can be set for 0 or 1°C

Error display

When there is any error, the LED on Display unit will blink and the LCD shows error status.

Error code	Description	LED Power blinking
Er : 03	Compressor overload protection	Yes
Er : 04	Anti overheat protection	Yes
Er : 05	Room sensor error	Yes
Er : 06	De-ice sensor error	Yes
Er : 07	Freeze sensor error	Yes
Er : 08	Protection & Alarm Damper	Yes

CHECK BEFORE CALLING THE SERVICE MAN – OPERATION INSTRUCTIONS

Check the following before contacting the service man. You may find the solution to your problems. After checking, if it still does not operate, please contact your local dealer.

PROBLEM	CAUSES
No operation	Check if electrical wire is damaged & check if breaker switch is still on. Check if the power supply is in order. Check if the timer switch is on or not.
The air conditioner runs but does not cool enough.	Check if the preset temperature is too high. Check if the sunlight shines directly into the room. Check if the door and the window are opened. Check if there is anything obstructing the air discharge. Check if the exhaust fan still operates. Check if the air filter is dirty or clogged.
Vapor or mist fume coming out of the unit while running.	Hot air in the room mixes with cool air. This causes smoke fume.
Inoperative remote control.	Loosened or disconnected wire between the unit and the remote control. Check if the batteries are inserted in correct directions. Check if the batteries are exhausted or not.